

RING S  
7634|7637



RING M  
7635|7638



RING L  
7636|7640

THIS PRODUCT CONTAINS A LIGHT SOURCE OF ENERGY EFFICIENCY CLASS: F

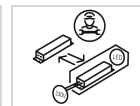
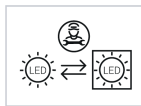

1

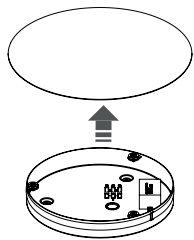

2

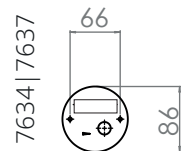
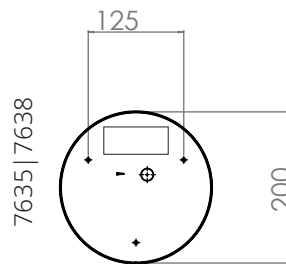
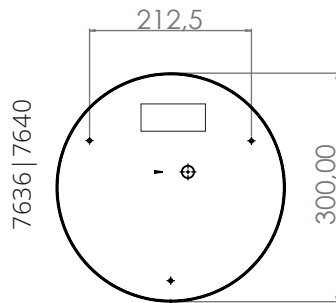

3

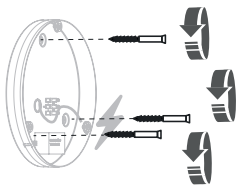

4

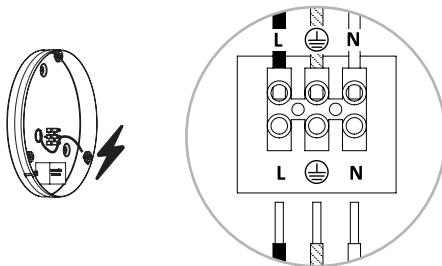

5

