

1806-1W

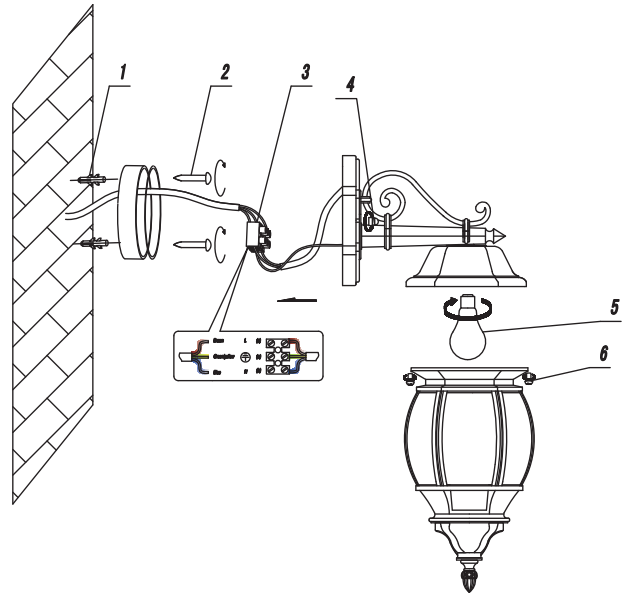

1807-1W

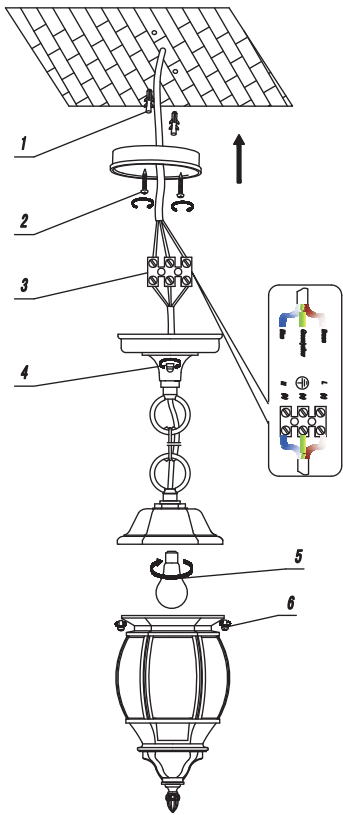

1806-1P

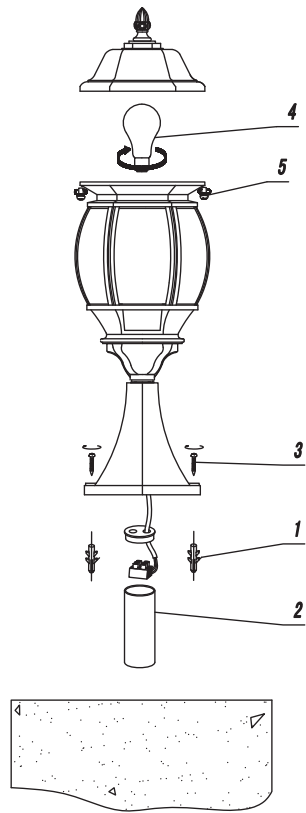

1806-1T

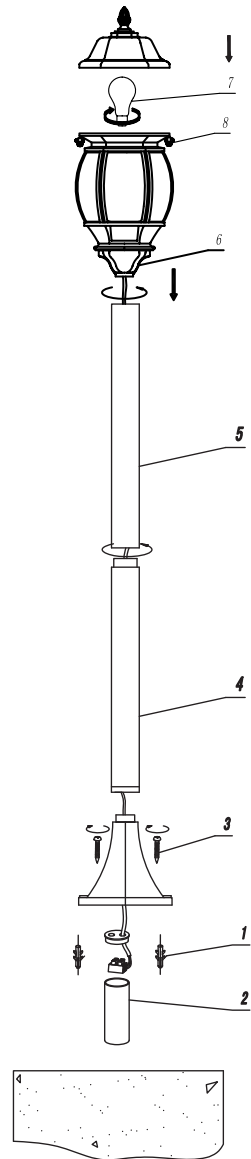

1806-1F

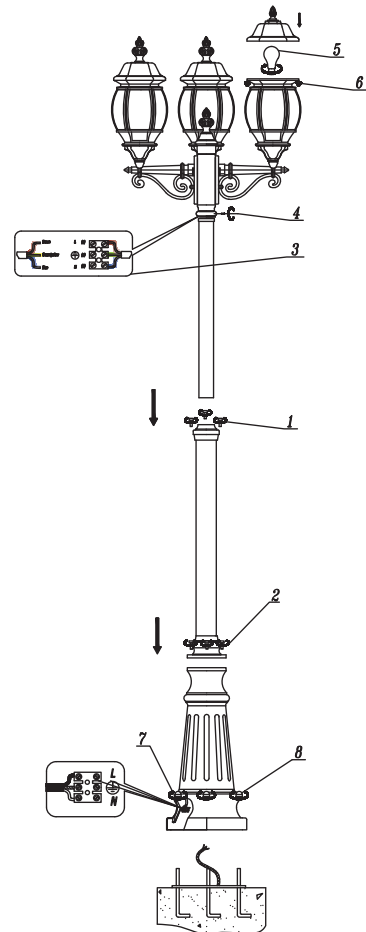

1806-3F